

orlight®

FROM SOURCE TO SITE

Installation instructions

LUMENFLEX-TOP - Flexible LED Strip

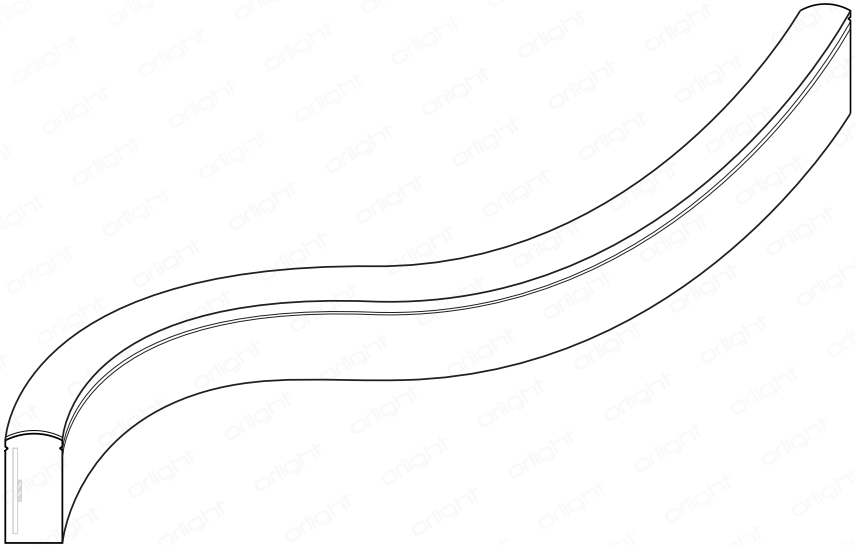

**SELF-LOCKING
50MM CLIP**

Recommended spacing
<500mm

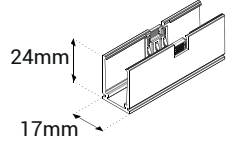

**SELF-LOCKING
PROFILE**

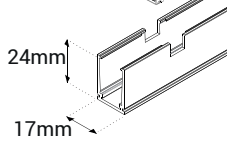

**STANDARD
PROFILE**

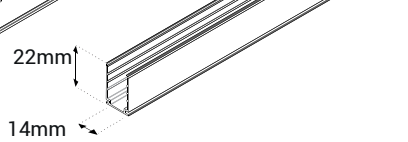

CORRECT BENDING

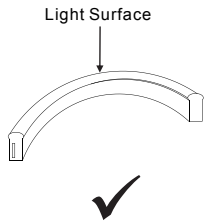
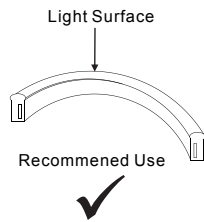
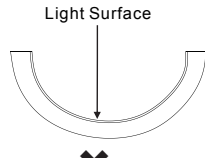
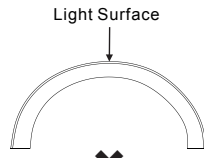
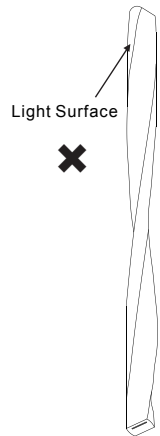

NOT SUITABLE FOR HANGING INSTALLATION

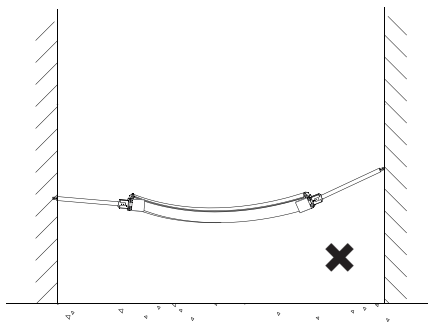
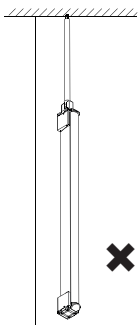

MINIMUM BEND DIAMETER

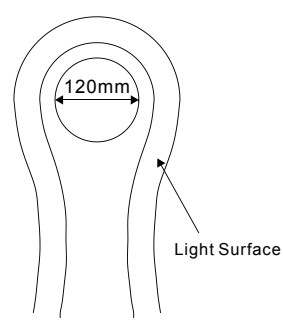

**SELF-LOCKING PROFILE
INSTALLATION**

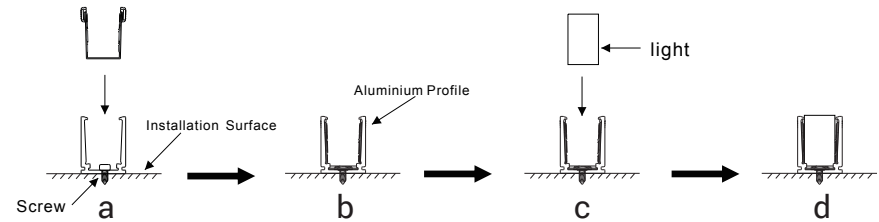
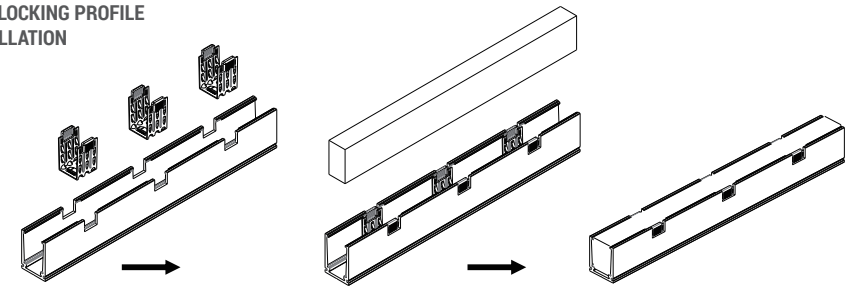

**STANDARD PROFILE
INSTALLATION**

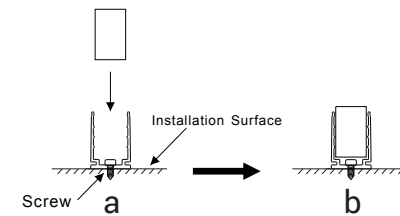
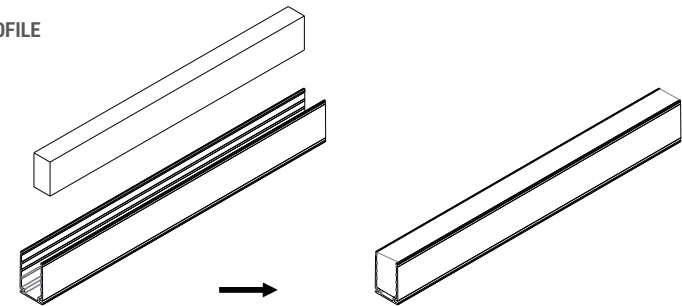

orlight®

FROM SOURCE TO SITE

www.orlight.com | 01923 851 890

We recommend that this product is installed by a competent person in accordance with the latest edition of the IET Wiring Regulations BS 7671 “Requirements for Electrical Installations” and the Buildings Regulations, as may be applicable subject to the location and country of the job or installation.

For more information and installation guide lines please refer to “Guide on Lighting Risks and Regulations” which can be downloaded from the website:

https://www.orlight.com/content/files/orlight/resources/Guide_on_Lighting_Risks_and_Regulations_2020.pdf

*** Please note, all information contained within this instruction manual is provided in good faith. We will not be held responsible for any losses incurred as a result of any inaccuracies contained within this document.**
